

CF0500ATCG | Angled Glass Top 427L Chest Freezer

Chest Freezers

CF0500ATCG

**ANGLED GLASS
TOP 427L CHEST
FREEZER**

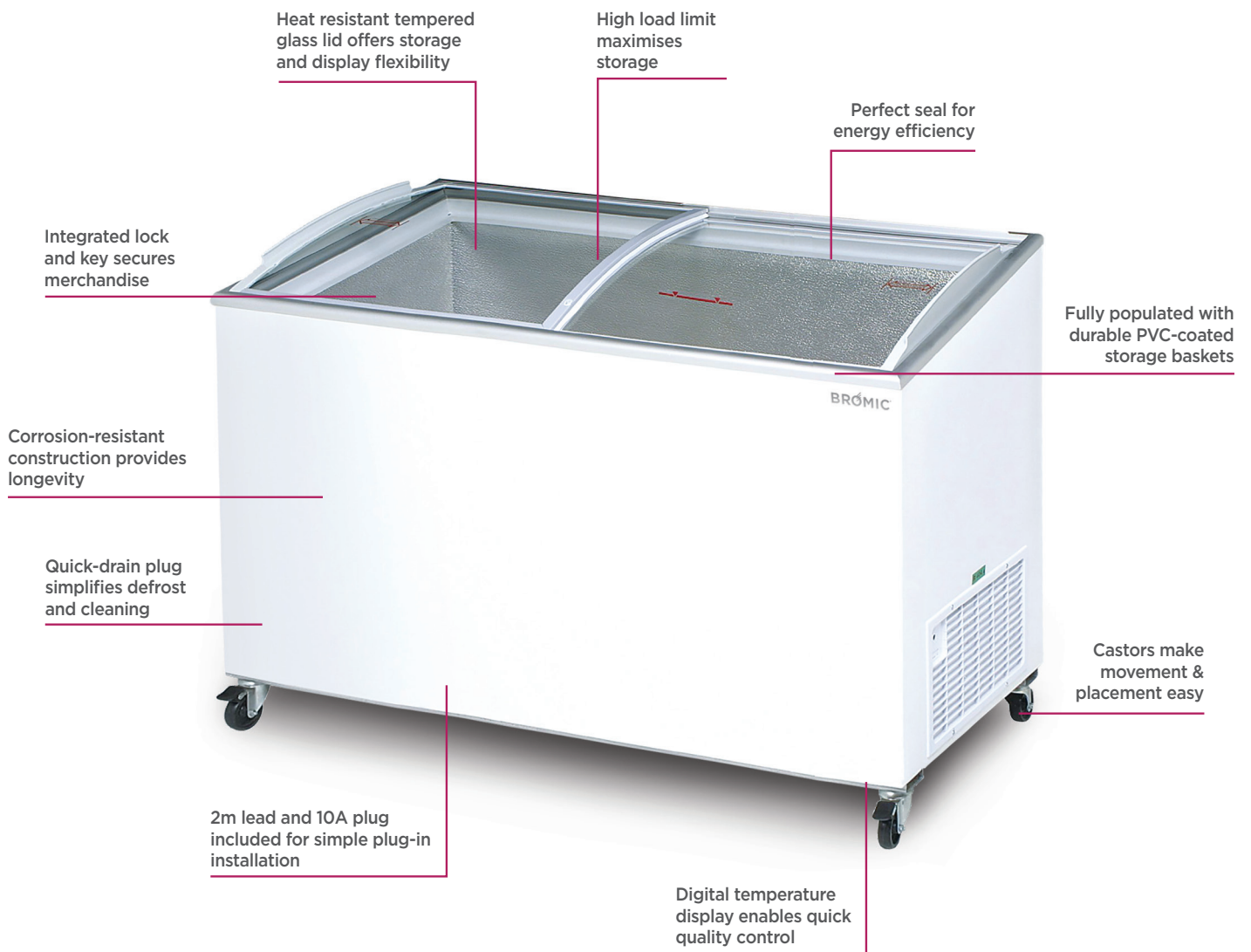

CF0500ATCG | Angled Glass Top 427L Chest Freezer

Chest Freezers

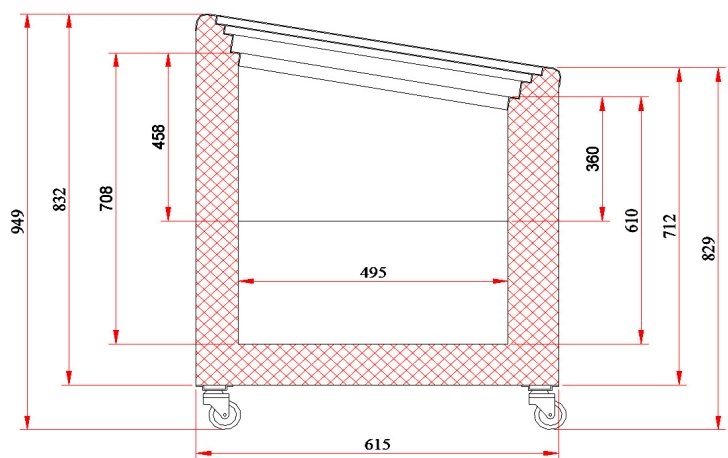
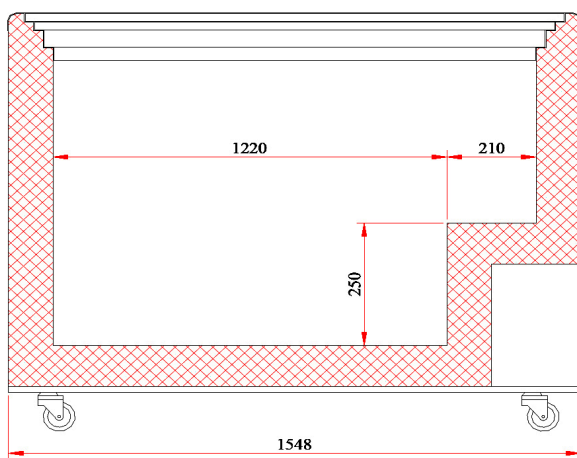

SPECIFICATIONS

Part Number	3736203	Internal Light	No
Capacity	427L	No. of Lids	2
Temperature range	-22 to -12°C	Lid Type	Slide - Glass
Max. Ambient Temp	35°C	Lid Shape	Curved
Refrigeration Capacity	400W	Lid Lock	Yes
Energy Consumption	6.4kWh/24h	Temp. Controller	Digital
Current	2.6A	Castors	Yes
Gross Weight	96kg	No. Baskets Included	6
Packaged Dimensions	1585 x 680 x 980 mm	Colour	White
Air-Circulation	Static	Warranty	2 Years, Parts & Labour
Refrigerant	R404a	Warranty Service	Bromic Extra Care
Plug Supplied	Yes, 1 x 10A		
Plug Location	2m long, bottom right rear		

DIMENSIONS

	External (mm)	Internal (mm)
Width	1548	1430
Depth	615	495
Height	949	708

All information is correct at the time of publication. BROMIC PTY Ltd reserve the right to alter specifications without notice.