

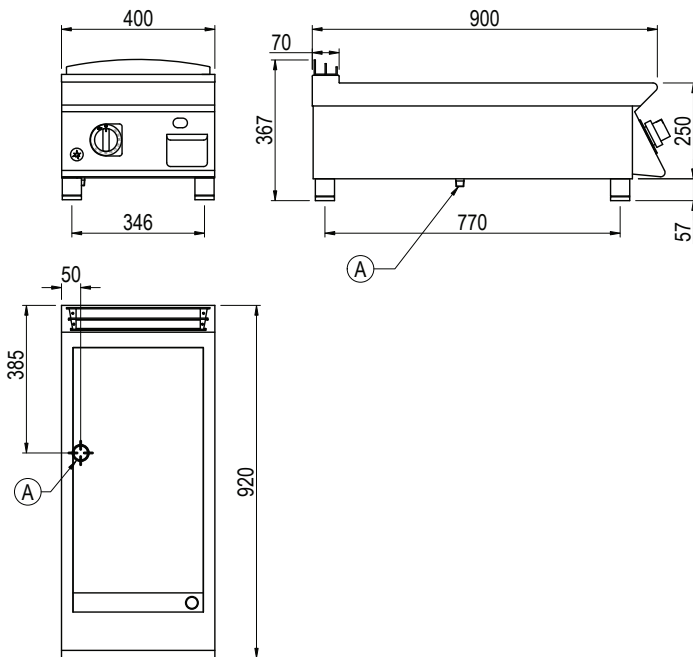

Product Information:

- Class leading, European style, professional quality and reliability since 1963
- 900 series, gas frytop with 15mm smooth satin chrome plate (32.4 MJ/h)
(also available in 15mm ribbed satin chrome plate)
- Satin chrome plate delivers a cost effective, highly durable, faster heating and easier cleaning solution than alternative plates
- Piezo ignition burners with flame failure device and pilot burner complete with Hi-limit temperature protection
- Temperature regulation via thermostat (90°C – 280°C)
- Robust 304 grade stainless steel construction with rounded corners for improved cleaning
- Hermetically sealed, pressed work surface with raised edges to protect from overflow
- Removable grease tray
- 24-month warranty

General Drawing:



Specifications:

Model - Smooth	FLG92TCRXT
Model - Ribbed	FRG92TCRXT
W x D x H (mm)	400 x 920 x 367
Weight	70kg
Cooktop (mm)	340 x 640
Packed Dimensions (mm)	450 x 1025 x 570
Packed Weight (mm)	77kg

	Natural	Universal LPG
Gas Connection	1/2" BSP	1/2" BSP
Minimum Normal Test Gas Pressure	1.3 kPa	2.75 kPa
Maximum Normal Test Gas Pressure	3.5 kPa	3.5 kPa
Nominal Test Point Pressure	1.0 kPa	2.65 kPa
Total Nominal Gas Consumption	32.4 MJ/h	32.4 MJ/h

Note: It is the responsibility of the installing gas plumber to ensure correct supply and connection sustaining appropriate pressure, when all installed gas appliances are operating at maximum.

Legend:

A Gas Connection