

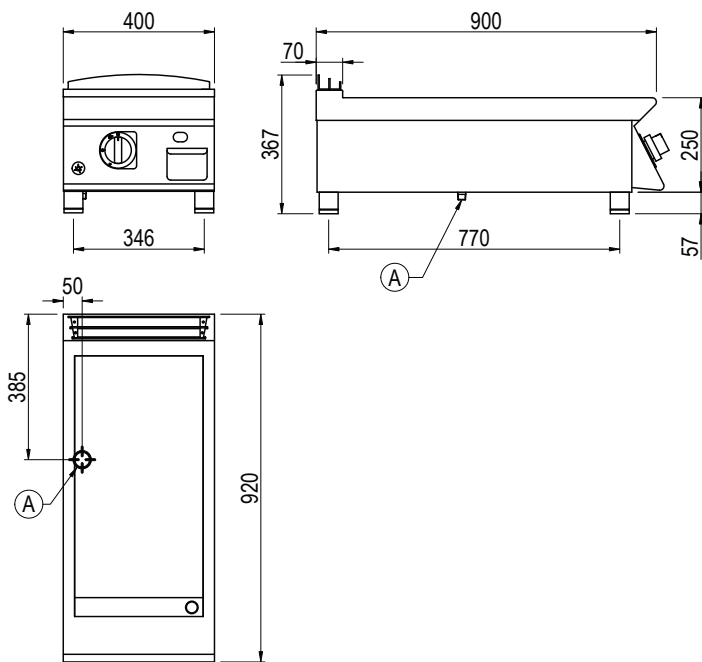

Product Information:

- Class leading, European style, professional quality and reliability since 1963
- 900 series, gas frytop with 12mm smooth mild steel plate (32.4 MJ/h) (also available in 12mm ribbed mild steel plate)
- Piezo ignition burners with flame failure device and pilot burner
- Temperature regulation via variable power flame control
- Robust 304 grade stainless steel construction with rounded corners for improved cleaning
- Hermetically sealed, pressed work surface with raised edges to protect from overflow
- Removable grease tray
- 24-month warranty

General Drawing:



Specifications:

Model - Smooth	FLG92TFT
Model - Ribbed	FRG92TFT
W x D x H (mm)	400 x 920 x 367
Weight	70kg
Cooktop (mm)	340 x 640
Packed Dimensions (mm)	450 x 1025 x 570
Packed Weight (mm)	77kg

	Natural	Universal LPG
Gas Connection	1/2" BSP	1/2" BSP
Minimum Normal Test Gas Pressure	1.3 kPa	2.75 kPa
Maximum Normal Test Gas Pressure	3.5 kPa	3.5 kPa
Nominal Test Point Pressure	1.0 kPa	2.65 kPa
Total Nominal Gas Consumption	32.4 MJ/h	32.4 MJ/h

Note: It is the responsibility of the installing gas plumber to ensure correct supply and connection sustaining appropriate pressure, when all installed gas appliances are operating at maximum.

Legend:

A Gas Connection