

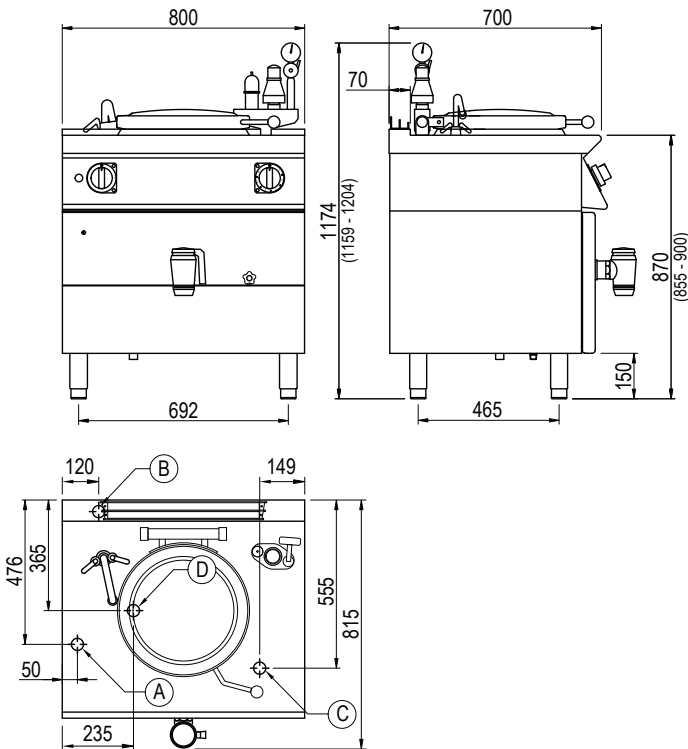

Product Information:

- Class leading, European style, professional quality and reliability since 1963
- 700 series, indirect heating electric boiling pan with 50 litre capacity (10.8kW)
- Steam jacketed kettle for even indirect heat over the entire cooking surface. Limit burning.
- Heating elements positioned inside the jacket gap with Hi-limit temperature protection
- Temperature regulation via 6 position selector
- Indicator lights to monitor the correct operation of the appliance
- Automatic fill jacket with pressure control via pressure gauge, safety valve and condensation valve
- Hot and cold water fill via integrated valve and spout
- Double skinned counterbalanced lid
- Pan emptied through front positioned tap with insulated grip
- 316 grade stainless steel pan base for superior corrosion resistance
- Robust 304 grade stainless steel construction with rounded corners for improved cleaning
- Height adjustable stainless steel feet for a 900mm working height
- All boiling pans are supplied standard with Reverse Osmosis Filtration system
- 24-month warranty

General Drawing:



Specifications:

Model	PEI705T.RO
W x D x H (mm)	800 x 815 x 1174
Weight	120kg
Capacity	50L
Packed Dimensions (mm)	820 x 845 x 1200
Packed Weight (mm)	127kg
Electrical Connection	3Ø + N + E 415VAC / 50Hz / 10.8kW

Legend:

- A** Electrical Connection
- B** Cold Water Connection 1/2" BSP
- C** Filtered Water Connection 1/2" BSP
- D** Drain Connection Ø38mm

Due to continuous product research and development, the information contained herein is subject to change without notice.

Revision: 01 - 03/02/2022 - A

www.stoddart.com.au

www.stoddart.co.nz

