

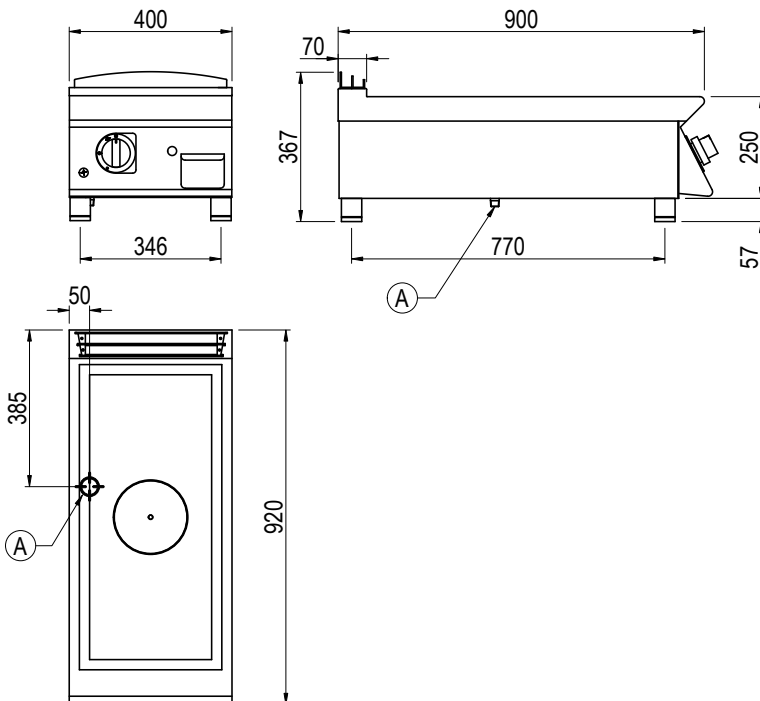

Product Information:

- Class leading, European style, professional quality and reliability since 1963
- 900 series, ultra-thick, reinforced radiant plate with central cut-out and high-power circular steel burner (28 MJ/h)
- Piezo ignition circular burner with flame failure device and pilot burner capable of reaching 500°C at the centre of the plate and 200°C around the edges
- Temperature regulation via variable power flame control
- Robust 304 grade stainless steel construction with rounded corners for improved cleaning
- Removable grease tray
- 24-month warranty

General Drawing:



Specifications:

Model	TG920TT	
W x D x H (mm)	400 x 920 x 367	
Weight	60kg	
Plate Dimensions (mm)	300 x 700	
Packed Dimensions (mm)	450 x 1025 x 570	
Packed Weight (mm)	67kg	
	Natural	Universal LPG
Gas Connection	1/2" BSP	1/2" BSP
Minimum Normal Test Gas Pressure	1.3 kPa	2.75 kPa
Maximum Normal Test Gas Pressure	3.5 kPa	3.5 kPa
Nominal Test Point Pressure	1.0 kPa	2.65 kPa
Total Nominal Gas Consumption	28 MJ/h	28 MJ/h

Note: It is the responsibility of the installing gas plumber to ensure correct supply and connection sustaining appropriate pressure, when all installed gas appliances are operating at maximum.

Legend:

A Gas Connection