

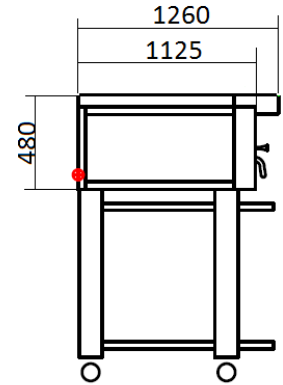

PM 911 ED

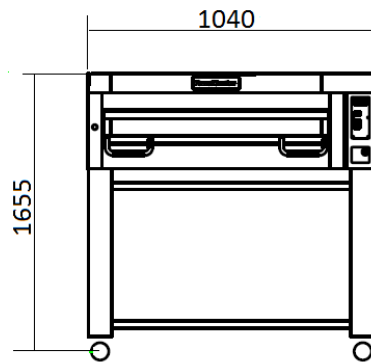

TECHNICAL INFORMATION

Category	900 Series (optimizes for pizzas up to 18 in)
Type	Free Standing
Construction	Stainless steel front
Colour	Classic Silver (Standard), Royal Gold (option), Phantom Black (Option)
Max. working temperature	400 ⁰ C, 500 ⁰ C (Option)
Weight (kg)	203
External Dimensions W x D x H (mm)	1040 x 1125 x 480
Internal Dimensions W x D x H (mm)	670 x 920 x 210 / 245 (Option)
Decks (special clay hearthstone)	1
Power connection	3 Phase, 400V, 50Hz,
Power consumption (kw)	8.5
Rated current (A)	20
Capacity (pizzas per deck) 10 in	6
Capacity (pizzas per deck) 14 in	3
Capacity (pizzas per deck) 16 in	2
Capacity (pizzas per deck) 18 in	1
Digital control panel	Standard

